

# Washroom



01 – 22  
SSS Washroom  
& Cloakroom



23 – 29  
White Washroom



30 – 36  
The National  
Key Scheme



37 – 43  
SSS Disabled



44 – 60  
White Disabled



61 – 70  
A Grade Disabled



71 – 74  
Anti Ligature



75 – 76  
Glass Hinges &  
Accessories



77 – 78  
No touch controls



80  
Request a  
Full Catalogue



## Key to finishes

<b>BLK</b> Black	<b>ELB</b> Electric Blue	<b>PSS</b> Polished Stainless Steel
<b>BRN</b> Brown	<b>G</b> Graphite	<b>RED</b> Red
<b>CHR</b> Chrome	<b>GRE</b> Green	<b>SB</b> Satin Brass
<b>CR</b> Cream	<b>GR</b> Grey	<b>SSS</b> Satin Stainless Steel
<b>DB</b> Dark Blue	<b>PK</b> Pink	<b>WHT</b> White
<b>DG</b> Dark Grey	<b>PB</b> Polished Brass	<b>YEL</b> Yellow

## Key to other symbols

<b>DOC M</b> DOC M Compliant	<b>kg</b> Maximum user weight (kg)
Suitable for Wet Areas	Suitable for outdoor use

## Warranties

<b>L<sup>w</sup></b>	<b>5<sup>w</sup></b>	<b>2<sup>w</sup></b>
Terms & Conditions apply.		

## Contacts

Sales  
T: (01474) 353111  
F: (01474) 353911  
E: sales@new-star.co.uk  
W: new-star.co.uk

## Surface mounting twin toilet roll dispenser

SSS

**3043**

Whole unit is made of SUS304 stainless steel with satin finish.

- Tumbler lock on door
- Holds and dispenses two rolls of standard toilet tissue
- Upper roll automatically lowers into position only when 95% of the bottom roll has been used

Size: 280 x 150 x 155mm



## Recessed mounting twin toilet roll dispenser

SSS

**3044**

Whole unit is made of SUS304 stainless steel with satin finish.

- Tumbler lock on door
- Holds and dispenses two rolls of standard toilet tissue
- Upper roll automatically lowers into position only when 95% of the bottom roll has been used

Size: 313 x 186 x 159mm  
Recess: 100mm



## Jumbo toilet tissue dispenser

SSS

**3047**

Whole unit is made of SUS304 stainless steel with satin finish.

- Tumbler lock

Size: 260 x 270 x 128mm



## Paper towel dispenser

SSS

**3055**

Made of SUS304 stainless steel with satin finish.

- Tumbler lock
- Surface mounting
- Refill indicator slots with continuous stainless steel piano hinge
- Capacity: 275 C-fold, 600 multi-fold or 400 single ply C-fold paper towels.

Size: 270 x 285 x 100mm



## Toilet roll holder

SSS

**131SC**

Made of SUS304 stainless steel with bright finish.

- Surface mounting
- Furnished with hood and chrome plated plastic roller

Size: 120 x 95 x 100mm



## Anti-vandal toilet roll holder

SSS

**3114**

Whole unit is made of SUS304 stainless steel with bright finish.

- Surface mounting
- Designed with vandal and theft resistant locking device, constant roll tension and exclusive adjusting mechanism to accommodate rolls from 106mm to 115mm width

Size: 70 x 150 x 110mm



## Toilet roll holder

PSS

**3039**

Made of SUS304 stainless steel brackets with bright finish.

- Concealed screw mounting
- Furnished with chrome plated plastic roller

Size: 53 x 143 x 100mm



Toilet roll holder  
**5014**  
 Projection: 55mm  $\phi$   
 Size: 90 x 150mm



Spare toilet roll holder  
**5014SP**  
 Projection: 60mm  $\phi$   
 Size: 34 x 120mm



Double toilet roll holder  
**5014E**  
 Projection: 55mm  $\phi$   
 Size: 90 x 285mm

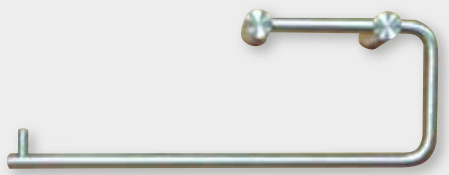

Toilet brush  
**5013**  
 Container: 250 x 90 $\phi$  x 60 $\phi$  mm  
 Holder: 90 x 110mm



Towel ring  
**5007**  
 Projection: 55mm  $\phi$   
 Size: 125 x 210mm



Vertical liquid soap dispenser  
**3092**



Vertical type surface mounted with concealed mounting bracket.

- Container body is made of heavy gauge SUS304 stainless steel
- Exposed surface with satin finish
- Furnished with large locked hinged stainless steel filter top
- Unbreakable refill indicator, valve has chrome plated brass cylinder and piston with stainless steel springs.

Capacity: 40 fl.oz. (1.18 litres)  
 Size: 205 x 125 x 110mm



Horizontal liquid soap dispenser  
**3094**



Horizontal type surface mounted with concealed mounting bracket.

- Container body is made of heavy gauge SUS304 stainless steel.
- Exposed surface with satin finish. Furnished with large locked hinged stainless steel filter top.
- Unbreakable refill indicator, valve has chrome plated brass cylinder and piston with stainless steel springs.

Capacity: 40 fl.oz. (1.18 litres)  
 Size: 125 x 205 x 110mm



## Budget soap dispenser

**3115**

Surface mounted non-corroding chrome plated valve, in white polyethylene container.

Capacity: 24 oz. (0.7 litre)

Size: 202 x 100 x 100mm



PCP WHT

## Stainless steel soap dispenser

**NS.WR129**

- Stainless steel construction
- Locking mechanism
- Visual indicator to show soap level

Capacity: 24 oz. (0.7 litre)

Size: 250 x 100 x 108mm

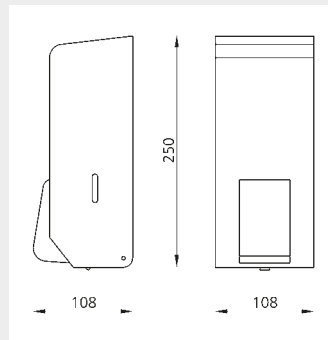

SSS PSS WHT

## Single towel rail

**5001**

Size: 55 x 600mm



SSS

## Double towel rail

**5002**

Size: 100 x 110 x 600mm



SSS

## Glass toiletry shelf

**5012**

Size: 100 x 110 x 600mm



SSS

## Towel Rail

**NS.WR115** – A-450mm

**NS.WR116** – A-600mm

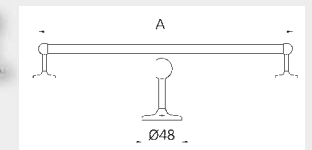

PCP

## Towel Ring

**NS.WR114**

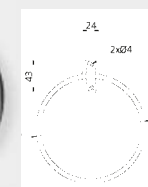

PCP



## Soap holder

**5019**

Size: 110 x 160mm



SSS

# SSS Washroom

## Oval Mirror

### NS.WR043

Size (mm): Width: 400  
Height: 498  
Projection: 12



PCP

## Soap Tray

### NS.WR044

Size (mm): Width: 197  
Height: 83  
Projection: 216



PCP

## Glass Shelf

### NS.WR045

Size (mm): Width: 520  
Height: 100  
Projection: 130

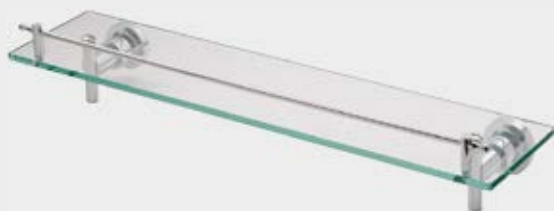

PCP

## Heavy duty recessed soap dish

### 3064

Made of heavy gauge SUS304 stainless steel with bright finish.

- Recessed mounting.
- Raised dimples on bottom of dish allow air to circulate under soap.

Wall Opening: 160w x 95h x 70d mm  
181 x 127 x 67mm



SSS

# SSS Washroom

## Overhead towel rack

### NS.WR030

Size (mm): Width: 730  
Height: 165  
Projection: 300



PCP

PCP

## Sponge holder

### NS.WR032

Size (mm): Width: 280  
Height: 90  
Projection: 180



PCP

## Triangular tray

### NS.WR033

Size (mm): Width: 230  
Height: 70  
Projection: 230

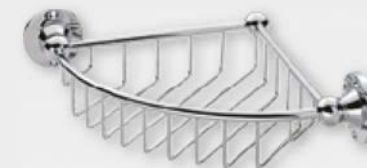

PCP

## Shower soap dish

### NS.WR034

Size (mm): Width: 195  
Height: 65  
Projection: 130



PCP

## Glass shelf

PCP

### NS.WR035

Size (mm): Width: 560  
Height: 60  
Projection: 105



## Toilet brush & holder

PCP

### NS.WR036

Size (mm): Width: 95  
Height: 375  
Projection: 172



## Soap dish holder

PCP

### NS.WR037

Size (mm): Width: 145  
Height: 52  
Projection: 120



## Soap dish holder

PCP

### NS.WR038

Size (mm): Width: 110  
Height: 90  
Projection: 165



## Tumbler holder

### 5020

Holder	Tumbler		
90 x 110 mm	110mm	75mm Ø	50mm Ø



SSS

## Tumbler holder

PCP

### NS.WR039

Size (mm): Width: 80  
Height: 115  
Projection: 127



## Double tumbler holder

PCP

### NS.WR040

Size (mm): Width: 177  
Height: 110  
Projection: 145



## Tumbler holder

PCP

### NS.WR041

Size (mm): Width: 125  
Height: 95  
Projection: 70



## Double tumbler holder

PCP

### NS.WR042

Size (mm): Width: 75  
Height: 93  
Projection: 98



# SSS Washroom

## Bottle opener

PSS

**3083**

- Made of SUS304 stainless steel with bright finish.
  - Exposed screw mounting.
- Size: 70 x 52 x 25mm



## Facial tissue dispenser

PCP

**3054**

- Surface mounting.
  - Polished chrome plated cold roll steel with front panel, hinged to container.
- Capacity: 300 single sheets or 150 two ply sheets.
- Size: 270 x 145 x 55mm



## Clothes line

**3090**

- Made of SUS304 stainless steel with bright finish.
- Provides centre locking knob to keep strain of cord when in used.
  - Furnished with retainer plate mount and 3M nylon clothes line.
- Size: 91mm diameter, 31mm projection.

PSS



# SSS Washroom

## Cosmetic/Shaving Mirror

CHR

**NS.MI1**

- 3 x Magnification with regular mirror on back
- Size: 200mm (D) with 240mm (L) extension and tilt.



## Illuminated Cosmetic/Shaving Mirror

CHR

- NS.MI2.S** - Single Arm
- Size: 215mm (D) with 315mm (L) extension.
- NS.MI2.D** - Double Arm
- Size: 425mm (L) extension.
- Voltage: 220v/240V
  - Output: 2W
  - 3x Magnification



## Battery Operated LED Square Illuminated Mirror

CHR

**NS.MI3**

- 3 x Magnification
- Size: 180mm (W) with 270mm (H)
- Extension max: 340 (L)



## Battery Operated LED Round Illuminated Mirror

CHR

**NS.MI4**

- 3 x Magnification
- Size: 180mm (D) with 285mm (H)
- Extension max: 340 (L)





Signage  
76mm Disc (16g)

SSS PSS PB PA



Round dustbin with foot pedal

**SB-501**

Type 430 stainless steel.

Overall Size: 210 x 300mm (Diameter x Height)



SSS

Free standing/wall mounted corner bin

**SB-371**

Made of SUS304 stainless steel with satin finish, c/w white basket inside.

- Free standing floor units

Size: 280 x 460 x 215mm



SSS

Towel and waste receptacle

**3121**

Made of SUS304 stainless steel with satin finish.

- Wall mounted or free standing floor units

Size: 357 x 430 x 168mm



SSS

Sanitary napkin and towel receptacle

**3131**

Made of SUS304 stainless steel with satin finish.

- Wall mounting unit
- Cover mounted on stainless steel piano hinge
- Lower trap door with self-closing lock

Size: 279 x 235 x 108mm



SSS

## Paper towel dispenser and waste disposal

**3128**

SUS304 stainless steel. Finishes: F24

- Dispenses 360 C-fold or 470 multi-fold paper towels.
- 2 gallons (9 litres) removable waste container.

Suggested mounting height:  
1711mm from floor to top of unit.

Wall Opening:  
324 x 673 x 108mm (W x H x D)

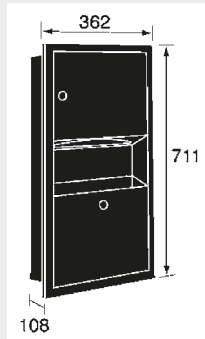

SSS

## Paper towel dispenser and waste disposal

**3129**

USU304 stainless steel. Finishes : F24

- Dispenses 600 C-fold or 800 multi-fold or 1100 single fold paper towels.
- Receptacle capacity 7 gallons (31.5 litres).

Suggested mounting height:  
1497mm from floor to top of unit.

Wall Opening:  
292 x 1359 x 159mm (W x H x D)

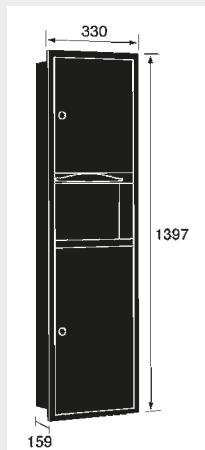

SSS

## Automatic Hand Dryer

WHT CE

**HK-1800PA**

- Plastic ABS cover.
- Power by 220VAC
- Watts: 1800W

Overall size: 268 W x 220 H x 170 D mm



Standard:  
EN60335-1: 2002 Household and similar electrical appliances – safety.  
Part 1: General requirements. EN 60335-2-23: 2003 Part 2-23 Particular requirements for appliances for skin care or hair care

## Push Button Hand Dryer

GR CE

**HK-2400PS**

- Enamelled steel cover
- Power by 220VAC
- Watts: 2400W

Overall size: 248 W x 248 H x 202 D mm



Standard:  
EN60335-1: 2002 Household and similar electrical appliances – safety.  
Part 1: General requirements. EN 60335-2-23: 2003 Part 2-23 Particular requirements for appliances for skin care or hair care

## Recessed Stainless Steel Changing Station

SSS

**BC2**

DDA compliant with welded stainless steel construction. Exposed surfaces are satin finish. Changing surface is high-impact resistant plastic shaped to cradle a child's body. Two-part adjustable safety strap and 400lb (181kg) load capacity assures child protection.

Overall size (open): 860 W x 650 H x 450 D mm



White available. Please see page 25.

# SSS Cloakroom

Single hook  
**5010**  
Overall 65mm  
Projection 55mm  $\phi$   
Upright 15mm  
 $\phi$  19mm



Buffered hook  
**5010B**  
Projection 78mm  
Upright 15mm  
 $\phi$  19mm



Double hook  
**5010D**  
Overall 65mm  
Projection 55mm  $\phi$   
Upright 15mm  
 $\phi$  19mm



Buffered Double hook  
**5010DB**  
Projection 78mm  
Upright 15mm  
 $\phi$  19mm



Hat and coat hook  
**IHC**  
Overall 68mm  
Projection 1 63mm  
Projection 2 30mm  
Return 1 21mm  
Return 2 17mm



Buffered hat and coat hook  
**IHCB**  
Overall 50mm  
Projection 1 80mm  
Projection 2 39mm  
Return 1 26mm  
Return 2 12mm



4 robe hook  
**5008**  
Projection 55mm  $\phi$   
Size 310mm



Coat hook  
**ICH**  
Overall 65mm  
Projection 29mm  
Return 17mm



# SSS Cloakroom

Open Coat Hanger  
**CE1**

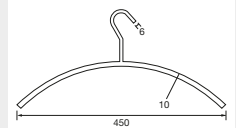
Closed Coat Hanger  
**CE2**

Wall Post  
**CE3**

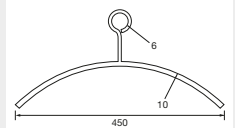
Double Wall Shelf  
**CE4**

Single Wall Shelf  
**CE5**

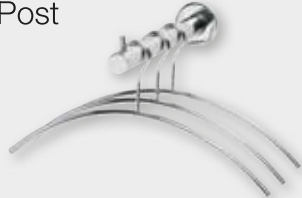
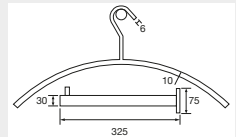
Hat & Coat Hook Rail  
**CE6**

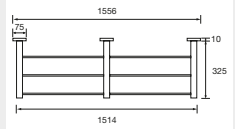

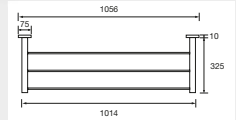

# SSS Washroom

# SSS Washroom

## Wall Mounted Drinking Fountain

### NS.WF1

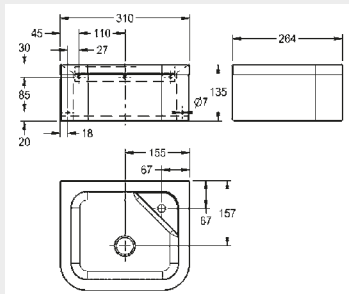
- Small, hygienic and built to last



SSS

## Drinking Fountain

### NS.WF3

- Use for high traffic area
- Chilled unit

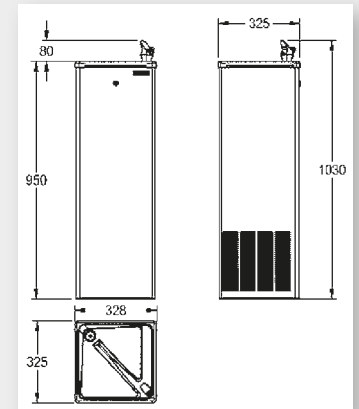

SSS

## Wall Mounted Drinking Fountain

### NS.WF2

- Supplied with bottle filter and tap

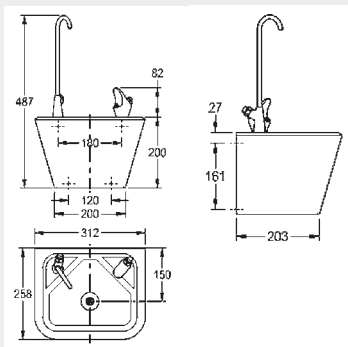

SSS

## Drinking Fountain

### NS.WF4

- Use for high traffic area
- Chilled unit

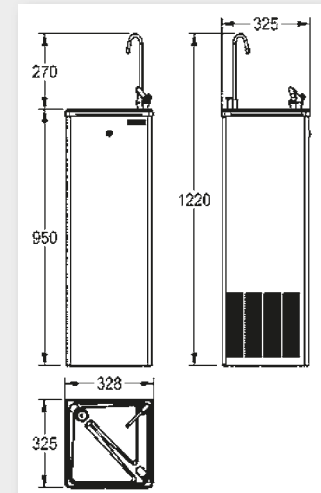

## Contemporary Double Towel Rail

**NS.CWR100**

- Durable Aluminium Construction

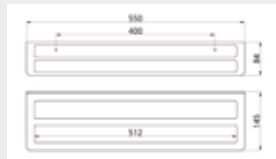

## Contemporary Bathroom Shelf

**NS.CWR101**

- Durable Aluminium Construction

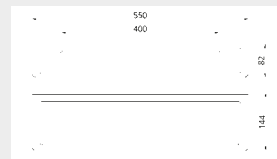

## Contemporary Soap Holder

**NS.CWR102**

- Durable Aluminium Construction

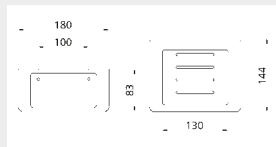

## Contemporary Toilet Roll Holder

**NS.CWR103**

- Durable Aluminium Construction

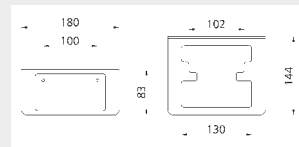

## Contemporary Soap Dispenser

**NS.CWR104**

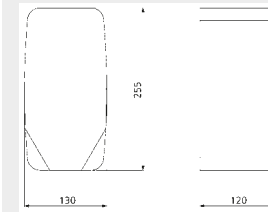

## Contemporary Toilet Paper Dispenser

**NS.CWR105**

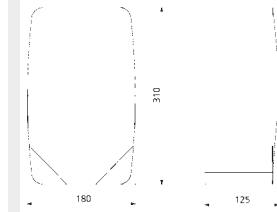

## Contemporary Hand Towel Dispenser

**NS.CWR106**

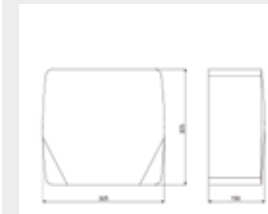

## Contemporary Hand Dryer

**NS.CWR107**



- Blue LED downlighter
- 550W super efficient motor
- Vandal resistant steel cover
- 10 second dry time



# White Washroom

# White Washroom

## Toilet roll dispenser

### NS.WR106

- Robust ABS plastic construction
- Refillable using industry standard paper rolls
- Locking mechanism
- Visual indicator to show paper level

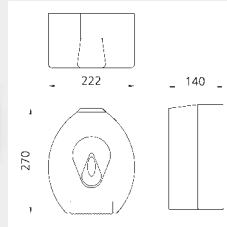

## Toilet tissue dispenser

### NS.WR107

- Robust ABS plastic construction
- Locking mechanism
- Visual indicator to show paper level

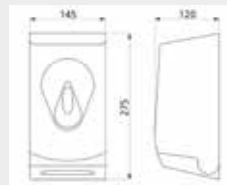

## Toilet roll holder

### NS.WR109 – Polished chrome plated

- Robust zinc die cast construction
- White plastic roller

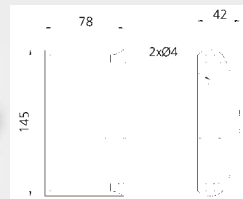

## Toilet roll holder

### NS.WR111 – Polished chrome plated

- Robust zinc die cast construction
- Lockable roller

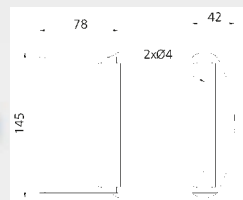

## Toilet seat ring only

### NS.WR100 – White

### NS.WR101 – Dark Blue

- Easy to install
- Stainless steel hinges

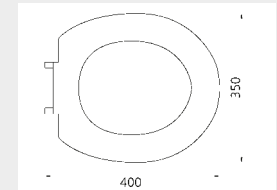

## Toilet seat with lid

### NS.WR102 – White

### NS.WR103 – Electric Blue

- Easy to install
- Includes lid
- Plastic hinges

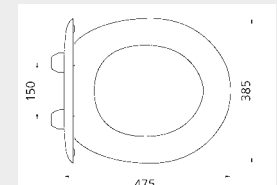

## Toilet seat ring only

### NS.WR200

- High quality duraplast construction
- Stainless steel hinges
- Comes with stays for side transfer

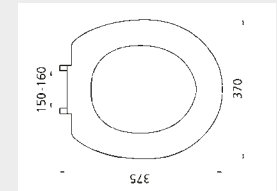

## Toilet seat with lid

### NS.WR201

- High quality duraplast construction
- Stainless steel hinges
- Comes with stays for side transfer

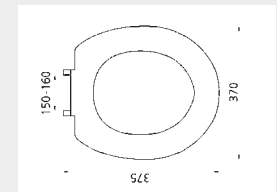

# White Washroom

## Shower curtain rail

- Tubular stainless steel construction
- Comes with ceiling stay
- Concealed wall fixings

	A	B
<b>NS.WR138</b>	1000	1000
<b>NS.WR139</b>	1200	1200
<b>NS.WR140</b>	2430	-

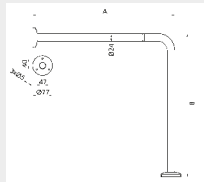

## Shower curtain

	A	B
<b>NS.WR007</b>	1800	1800
<b>NW.WR008</b>	1800	2000
<b>NS.WR009</b>	2000	2000
<b>NW.WR010</b>	2200	2000
<b>NW.WR011</b>	2500	2000
<b>NW.WR012</b>	3000	2000

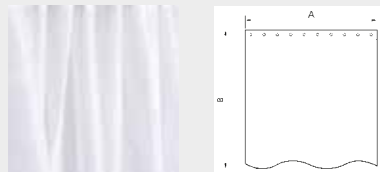

## Baby change station

**9012**

The built-in dispenser for towels or sanitary liners, hooks for nappy bags and handbags plus multi-lingual instructions for added convenience.

Fabricated of high impact-plastic.

Overall size: 920w x 570h x 100d mm

Open size: 920w x 570h x 520d mm

Maximum capacity: 136.10kg



Federal ADA accessibility guidelines CALDAG and CABO/ANSI A117.1992  
Tested to ASTM G21 and G22



# White Washroom

## Paper towel dispenser

**NS.WR117**

- Robust ABS plastic construction
- Locking mechanism
- Visual indicator to show paper level

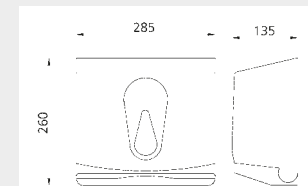

## Warm air dryer

**NS.WR133**

- Sensor operated
- Durable white enamelled steel construction
- 2.4kw, 230/240v power

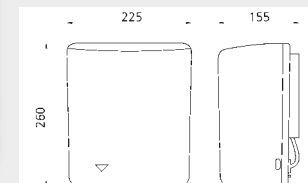

## Soap dispenser

**NS.WR112**

- Robust ABS plastic construction
- Locking mechanism
- Visual indicator to show soap level

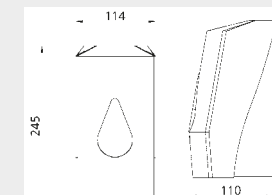

## Soap dish

**NS.WR113**

- Robust zinc die cast construction
- Removable white plastic liner

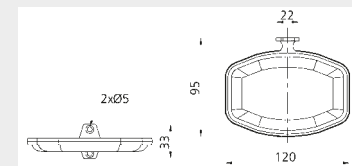

# White Washroom

## Multi swing arm towel rail

**NS.WR136** – Tripple arm

- White epoxy coated steel tubular construction
- Available with three swing arms
- Concealed fixings

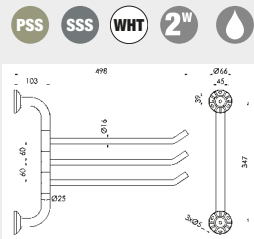
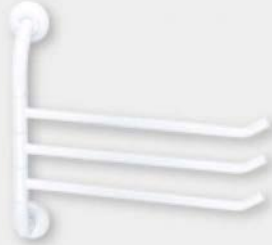

## Multi swing arm towel rail

**NS.WR137** – Two arm

- White epoxy coated steel tubular construction
- Available with two swing arms
- Concealed fixings

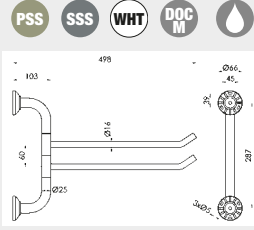
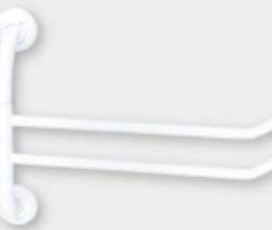

## Washroom cabinet – lockable

**NS.WR122**

- Robust steel construction
- Epoxy powder coated
- Locking door

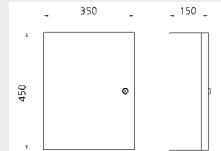

## Safety backed glass mirror

**NS.WR134** – 1000 mm

**NS.WR135** – 700 mm

- Bevelled edge
- Safety backed

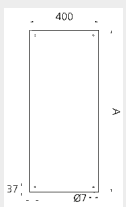
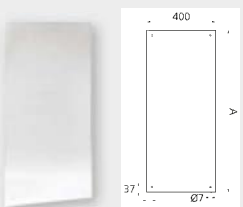

## Single robe hook

**NS.WR118** – White

**NS.WR119** – Dark blue

**NS.WR120** – Electric Blue

**NS.WR121** – Grey

- Aluminium construction

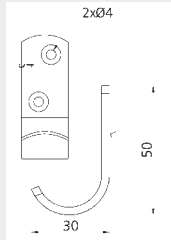

# White Washroom

## Shower Cubicle Telescopic Rod

**NS.WRTR1**

- Extends from 700mm to 1220mm



## 6 ft Telescopic Rod

**NS.WRTR2**

- Extends from 1100mm to 1830mm

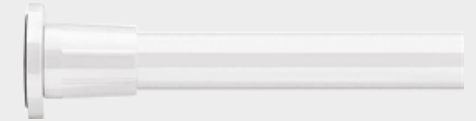

## 8 ft 6” Telescopic Rod

**NS.WRTR3**

- Extends from 1100mm to 2600mm



## L Shaped Telescopic Rod

**NS.WRTR4**

- Fixed width rod is 740mm
- Length of rod extends from 1400mm to 2600mm







## Shower Curtain Track

- High quality aluminium track
- Designed to eliminate dust and dirt traps
- Supplied with wall brackets, ceiling stay and concealed runners
- Can be trimmed to length



L Shaped	A	B
<b>NS.WR001</b>	1000	1000
<b>NS.WR002</b>	1200	1200
<b>NS.WR003</b>	1500	1200
<b>NS.WR004</b>	1830	760

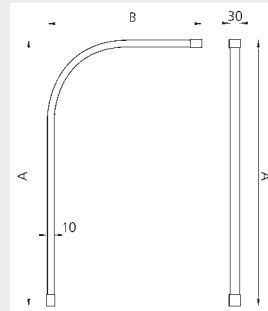

Straight	A
<b>NS.WR005</b>	2430

## Flexible shower curtain track

### NS.WR006

- High quality aluminium track which can be bent by hand on site
- Designed to eliminate dust and dirt traps
- Supplied with wall brackets, ceiling stay and concealed runners
- Can be trimmed to length

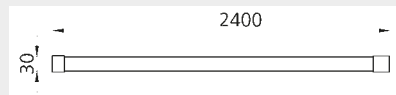

Opening doors to independent living – the NKS (National Key Scheme) Key, operates over 9,000 locked accessible toilets across the UK. National Key Scheme approved keys are available to people who require use of the toilet facilities due to their disability or health condition.

The objective of the NKS Locks is to ensure that public toilets are available to the disabled free from misuse and vandalism, to ensure a certain level of hygiene is maintained. The National Key Scheme offers disabled people independent access to locked public toilets around the country. Toilets fitted with National Key Scheme locks can now be found in shopping centres, pubs, cafés, department stores, bus and train stations and many other locations in most parts of the country.

The scheme offers the opportunity to extend these standards to disabled toilets within public buildings, offices etc. It is hoped that the flexibility of design now offered by the NEWSTAR range will encourage architects and facility management companies to extend its range of use ensuring keyed access only to disabled toilets providing designed benefits to architects and improvements in both security and hygiene to facility maintenance companies. BS 8300:2001 states “Some disabled people need to use a toilet more frequently than other users, making it desirable that accessible toilets are not made generally available to the public. Whether disabled people have exclusive use of an accessible toilet or are given priority use is a facilities management issue”.

The National Key Scheme guide is a written guide to the 9,000 NKS toilets and local services throughout the UK. Providers of toilets for disabled people fit NKS locks to keep their facilities in good condition. Over 25 years the Scheme has been adopted by 400+ local authorities and many transport, retail and leisure providers. This valuable resource is the only guide of its kind and really does open doors to independent living. Also available is a smartphone App allowing you to Instantly locate your nearest toilet facility and get directions by road, bus or foot.



## BARYCOMPLETE.RH.SSS



## BARYCOMPLETE.LH.SSS

The new enhanced NKS lock is now made as standard in Satin Stainless Steel (Grade 316) which is suitable for external use in excessive climatic conditions. The lever handle is a return to door safety type and complies with current DDA regulations. Externally a red and white indicator identifies the toilets current status, there is a built in coin emergency release plus anti-vandal external bolt fixings. All locks come with one standard key to be used for fitting.

### Interchangeable

The NEWSTAR NKS lock can be operated with all current NKS keys on the market. In addition you can retro fit a NEWSTAR NKS lock into any existing mortises without further adjustment.

### Functionality

The lock is operated from the inside via the standard lever operation that retracts the latch. The lever when in the horizontal position can be lifted up to ensure that the latch bolt is locked. When lifted the red indicator shows on the outside, the key will not operate the lock, although emergency access is available via the built in coin emergency release. External access is via key only when white indicator is showing, coin emergency release when indicator is red. Once the door is closed again, it will automatically lock.

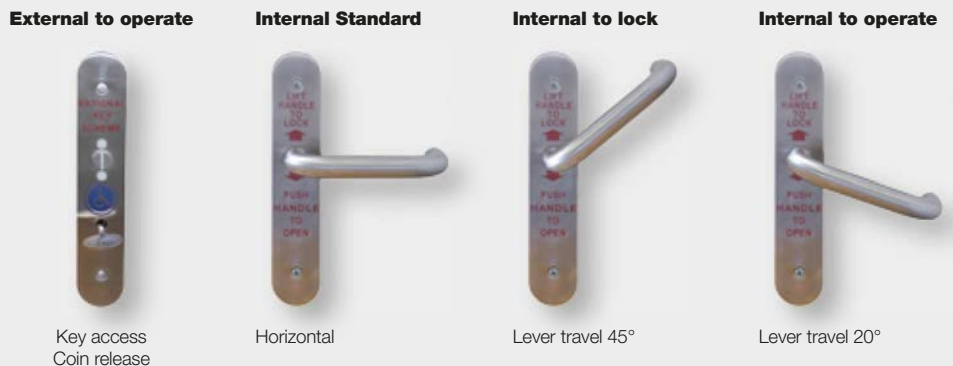

**Handing**  
The lever furniture is handed but the lock is reversible.

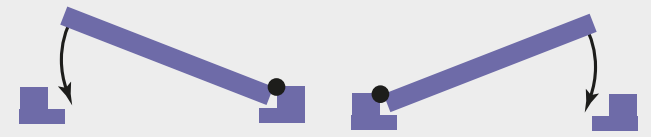

When standing inside toilet **Right hand door hinged on right** **Left hand door hinged on left**

## Light reflective value NKS Lockset

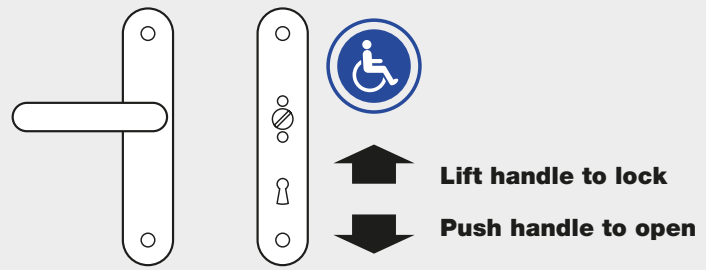

Colour differentiation has become focal to help meet the duties of the Disability Discrimination Act (DDA), guidance in Approved Document Part M recommends that adjacent critical surfaces (i.e. ceiling/wall/door and floor) have a visual contrast of 30 LRV difference. LRV (Light Reflective Value) is defined as the amount of light reflected by that colour, measured on a scale of 0-100.

NEWSTAR offer the opportunity to colour coat the NKS lever set to meet the requirements of Light Reflective Values required by the visual contrast demands of BS8300 noting the difference between door furniture and the face of the door. The current BS8300 and Approved Document M (the section of the UK building regulations which sets down minimum standards for disabled access in the built environment) require a contrast of greater than 30 points between these two elements. When following this method of supply two additional matching instruction signs are provided with instructions as supplied on the standard lockset. All functionality, interchangeability and handing remain the same as the standard NKS lockset.

\* Note: We do not recommend this process for external areas.

<b>Buttercup Yellow</b> RAL 085 80 80 RAL 1023 s1070-y10r	<b>80 Coffee Brown</b> RAL 060 20 05 RAL 8022 S 8502-R	<b>59 Ice Blue</b> RAL 2309005-S0510-R90B	<b>33 Ruby Red</b> RAL 030 30 45 RAL 3003 S 3560-R
<b>76 Lime Green</b> RAL 1408040-S0550-G10Y	<b>Jet Black</b> RAL 9005 S 9000-N	<b>Stone Grey</b> RAL 140 60 05-S3502-G	<b>Vanilla</b> RAL 1009010-S0510-G80Y
<b>53 Ultramarine Blue</b> RAL 5022 S 4550-R80B	<b>70 Forest Green</b> RAL 180 20 15 RAL 6012 S 8010-B70G	<b>50 Steel Blue</b> RAL 260 20 15 RAL 5011 S 7020-R80B	<b>99 Pure White</b> RAL 100 90 05 RAL 9010 S 0502-G50Y
<b>56 Lilac Blue</b> RAL 260 60 25-s2040-r80b	<b>30 Burgundy</b> RAL 020 20 20 RAL 3007 S 7020-R108	<b>79 Pistachio Green</b> RAL 130 90 10-S0520-G30Y	<b>Light Grey</b> RAL 000 80 00 RAL 7035 S 2000-N
<b>92 Anthracite Grey</b> RAL 240 30 05 RAL 7016 S 8005-R80B	<b>16 Blossom Yellow</b> RAL 0959040-S0530Y50R		

Other colours available. Quote your RAL number. Set up charge applicable.

RAL number. Set up charge applicable

Light reflective value NKS Lockset  
(Stocked Product)

**BARYCOMPLETE.RH.WHT**  
**BARYCOMPLETE.LH.WHT**

99 Pure White  
RAL 100 90 05  
RAL 9010 S 0502-G50Y

**BARYCOMPLETE.RH.DB**  
**BARYCOMPLETE.LH.DB**

53 Ultramarine Blue  
RAL 5002 S 4550-R80B



Please note we do not recommend for external areas

New National Key Scheme key  
**BARY.NKS.KEY**

The new NKS keys are available from [new-star.co.uk](http://new-star.co.uk) and selected wholesalers. It has been designed to encompass more users and allow ease of use.

**Key features include;**

- Extremely tactile
- Bow allows ease of use
- NKS logo
- National Key Scheme (NKS) identification
- Key Ring hole
- Braille identification
- Bright red bow.



## NKS Bespoke for Architects and Designers

Now there are no limitations to the furniture design suitable for your disabled toilet. Please note for all bespoke designs we will require details of the likely conditions where the door is going to be used, to ensure we use the correct material.

Examples of designs.



## NKS New Frontiers

NEWSTAR are developing the National Key Scheme lock to applications where users have suggested a need. Below are two such applications currently in development. If you find these applications suitable for your needs, please contact Newstar for an update.

### Portaloos

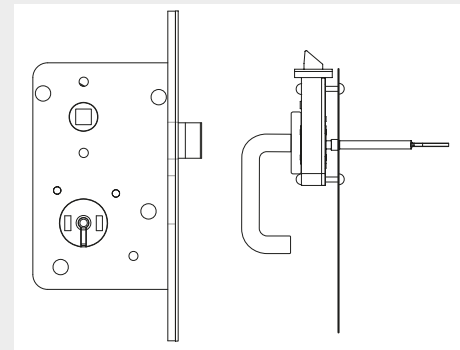

Disabled portaloos are currently not fitted with NKS locks and are therefore open to public misuse and abuse. The objective of the NKS key is to ensure that public toilets available to the disabled are free from misuse and vandalism, to ensure a certain level of hygiene is maintained.

### Sliding Doors

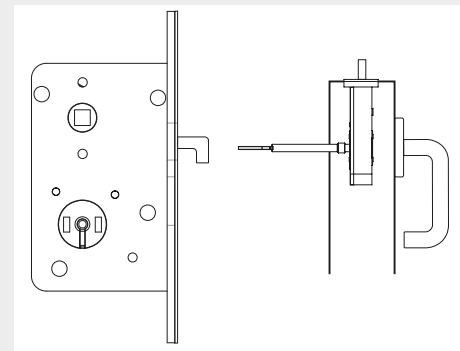

The introduction of this product into the NKS range will enable Architects and Designers to make better use of the space available to them. It should be noted that when considering this option the opening should be greater than DDA requirements as the door will not fully recess due to the lever and plate being face fixed.

# SSS Disabled

## Hinged support rail

**FS004.700**

Whole unit is made of heavy gauge SUS304 stainless steel with satin finish.

- BS8300 compliant
- Special design for handicapped toilet.
- Exposed screw mounting.
- A safety button designed to secure the grab bar in vertical position.
- Furnished with 32mm diameter x 700mm length swings up grab bar.



SSS

## Backrest C/W cushion

**BR1**



SSS

## Grab bar C/W concealed rose

**SGB2.32.450.SSS**

**SGB2.32.600.SSS**

- BS8300 compliant
- Concealed screw mounting.
- Grab bar fabricated with 1.2mm thickness of SUS304 stainless steel.
- Tubing to be bent and welding to the stainless steel flange with stainless steel cover, easy to snap-on.
- Standard Clearance: 60mm between the finished wall surface and the inner edge of the tubing.



SSS

# SSS Disabled

## Stainless steel grab rail

- Non corrosive 304 grade stainless steel construction
- Flange covers to conceal wall fixings
- Choice of lengths and configurations

	A (mm)
<b>SGB3.32.300</b>	300
<b>SGB3.32.450</b>	450
<b>SGB3.32.600</b>	600
<b>SGB3.32.900</b>	900



SSS PSS 190 LW

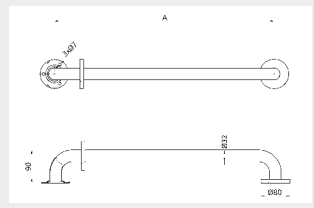

## Stainless steel 135° cranked grab rail

- Non corrosive 304 grade stainless steel construction
- Flange covers to conceal wall fixings
- Choice of lengths and configurations

	A (mm)
<b>SCRGB.150</b>	150
<b>SCRGB.300</b>	300
<b>SCRGB.450</b>	450



SSS PSS DOC M 190 LW

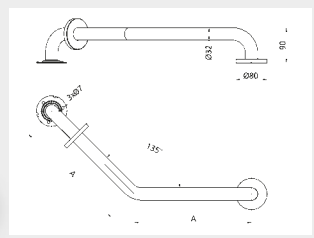

## Stainless steel 90° angled grab rail

- Non corrosive 304 grade stainless steel construction
- Flange covers to conceal wall fixings
- Choice of lengths and configurations

	A (mm)
<b>SAGB.450</b>	450
<b>SAGB.600</b>	600



SSS PSS DOC M 190 LW

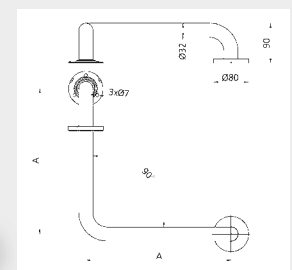

## Stainless steel back rest rail and pad

### BRS1

- Non-corrosive 304 grad stainless steel construction
- Durable wipe clean pad
- Flange covers to conceal wall fixings

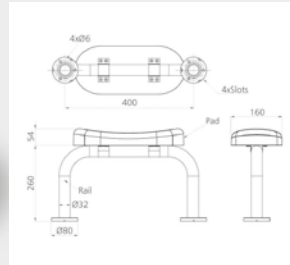

## Stainless steel back rest rail

### BRS2

- Non-corrosive 304 grad stainless steel construction
- Durable wipe clean pad
- Flange covers to conceal wall fixings

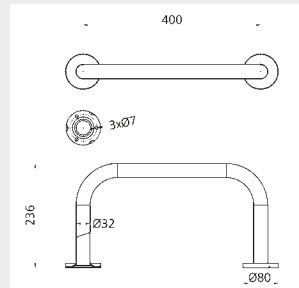

## Replacement pad to fit 32mm rail

### BR3

- Non-corrosive 304 grade stainless steel construction
- Lift and drop hinge mechanism with minimal lateral movement
- Plastic covers for wall fixings available

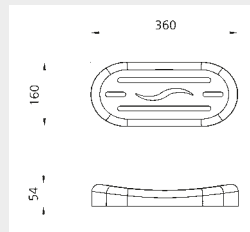

## Stainless steel hinged support rail

### HSR7

#### HSR7-T - with toilet roll holder

- Non-corrosive 304 grade stainless steel construction
- Lift and drop hinge mechanism with minimal lateral movement
- Plastic covers for wall fixings available

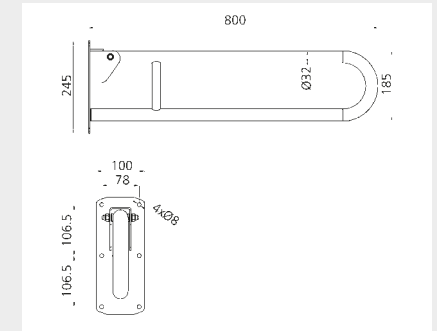

## Stainless steel hinged support rail with support leg

### HSR8

#### HSR8-T - with toilet roll holder

- Non-corrosive 304 grade stainless steel construction
- Lift and drop hinge mechanism with minimal lateral movement
- Plastic covers for wall fixings available
- Adjustable folding support leg for extra strength with 25mm
- Increments and fine adjustment using threaded foot

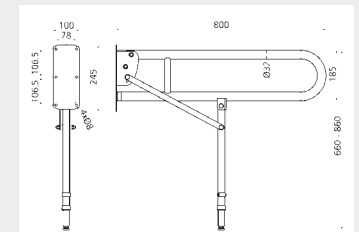

## Premium friction stainless steel hinged rail

### HSR9.800

- 800mm
- Non-corrosive 304 grade stainless steel construction
- No lateral movement in hinge mechanism
- Durable stainless steel flange cover to conceal wall fixings

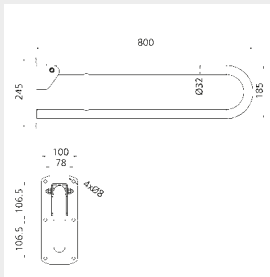

## Folding shower seat

### 3091C

- Constructed of 25mm diameter, SUS304 stainless steel with satin finish.
  - Furnished with self-locking mechanism
- Flange: 80mm diameter, exposed screw type.  
Size: 390 x 430 x 464 mm



## Doc M toilet packs

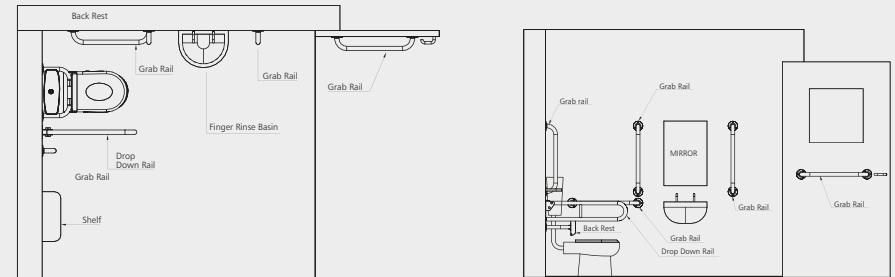

Drawings are for guidance only, please refer to relevant building regulations

## Standard Doc M pack

### DOCMST

- Simple one box solution to meet Doc M spec
- High resistance to vandalism
- All components available as individual products for continuity of specification



Contents	Qty
700mm hinged support rail	1
600mm grab rail with concealed fixing	4
450mm grab rail with concealed fixing	1
Newstar back rest rail and pad with concealed fixing	1



# SSS Disabled

# White Disabled

## Rail only closed coupled Doc M pack



### DOCM5

- Simple one box solution to meet Doc M spec
- High resistance to vandalism
- All components available as individual products for continuity of specification

Contents	Qty
800mm premium hinged support rail	1
600mm premium grab rail with concealed fixing	4
450mm premium grab rail with concealed fixing	1



## Rail only low level Doc M pack



### DOCM6

- Simple one box solution to meet Doc M spec
- High resistance to vandalism
- All components available as individual products for continuity of specification

Contents	Qty
800mm premium hinged support rail	1
600mm premium grab rail with concealed fixing	4
450mm premium grab rail with concealed fixing	1
Premium back rest rail and pad with concealed fixing	1



## Trombone hinged support rail



### HSR1

- Robust mild steel construction
- Lift and drop folding mechanism with minimal lateral movement
- 800mm (A)

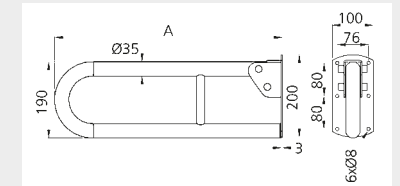

## Trombone hinged support rail with leg



### HSR2

- Adjustable folding support leg for extra strength with 25mm increments and fine adjustment using threaded foot
- Lift and drop folding mechanism with minimal lateral movement
- 800mm (A)

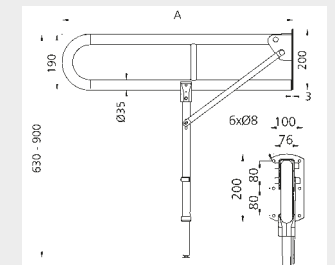



# White Disabled

## Floor mounting post and adaption kit for trombone hinged rail

Product Code	A (mm)
<b>HSRAK.60</b>	60

- For use with trombone hinged rails
- Ideal for use where wall substrate is unstable
- Hinged rail can be mounted at variable height

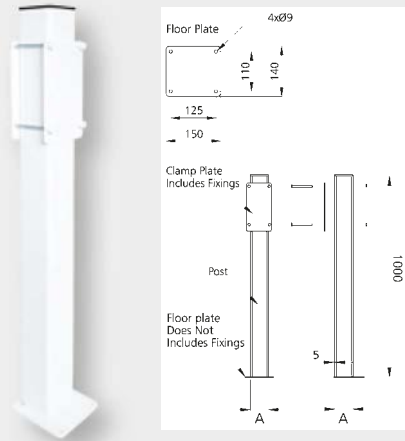

# White Disabled

## Round flange steel grab rail - 25mm diameter tube

Product Code	A (mm)
<b>SGB1.25.305</b>	305
<b>SGB1.25.455</b>	455
<b>SGB1.25.610</b>	610

- Robust mild steel construction
- Durable epoxy coated finish

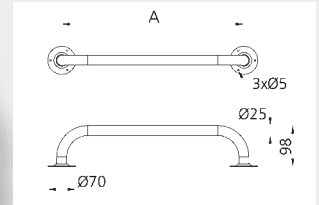

## Round flange steel grab rail - 35mm diameter tube

Product Code	A (mm)
<b>SGB1.35.305</b>	305
<b>SGB1.35.455</b>	455
<b>SGB1.35.610</b>	610
<b>SGB1.35.915</b>	915

- Robust mild steel construction
- Durable epoxy coated finish
- Raised flange to allow for uneven wall surfaces

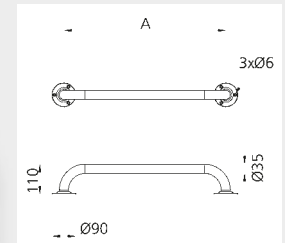

## Spring loaded hinged support rail

### HSR6

- Spring loaded hinge mechanism for ease of use
- No lateral movement

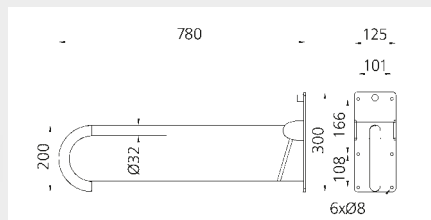

## Flat end steel grab rail

Product Code	A (mm)
<b>FEGB1.305</b>	305
<b>FEGB1.455</b>	455
<b>FEGB1.610</b>	610
<b>FEGB1.710</b>	710
<b>FEGB1.915</b>	915

- Narrow flange designed for use in limited flange mounting space
- Robust mild steel construction
- Durable epoxy coated finish

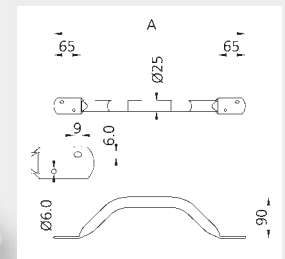

# White Disabled

## Off-set flat end steel grab rail



Product Code	A (mm)
<b>OFEGB.455</b>	455
<b>OFEGB.610</b>	610
<b>OFEGB.710</b>	710

- Off-set to allow safe hand grip next to doorways
- Robust mild steel construction
- Durable epoxy coated finish

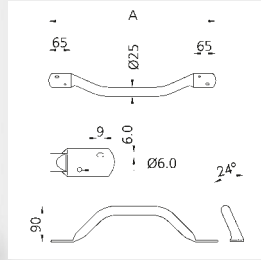

## Newel post grab rail

**NGB.LH.WHT**

**NGB.RH.WHT**

- Provides additional support when stepping onto stairs
- Robust mild steel construction
- Small flange for ease of fitting to modern newel posts

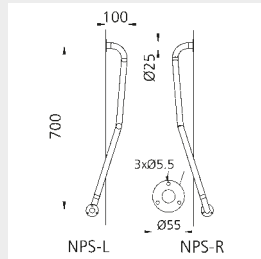

## Plastic fluted grab rail



Product Code	A (mm)
<b>PFGB.300</b>	300
<b>PFGB.450</b>	450
<b>PFGB.600</b>	600
<b>PFGB.900</b>	900

- High Quality extruded PVC Plastic
- UV stabilised to prevent discolouration
- No electrical earthing required

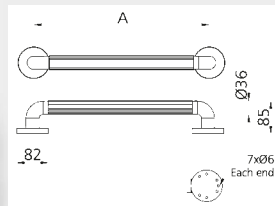

# White Disabled

## Plastic fluted 135° cranked grab rail



Product Code	A (mm)
<b>PFGB.135.150</b>	150
<b>PFGB.135.300</b>	300
<b>PFGB.135.450</b>	450

- High Quality extruded PVC Plastic
- UV stabilised to prevent discolouration
- No electrical earthing required

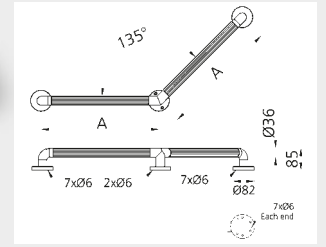

## Plastic fluted 90° angled grab rail



Product Code	A (mm)
<b>PFGB.90.450</b>	450
<b>PFGB.90.600</b>	600

- High Quality extruded PVC Plastic
- UV stabilised to prevent discolouration
- No electrical earthing required

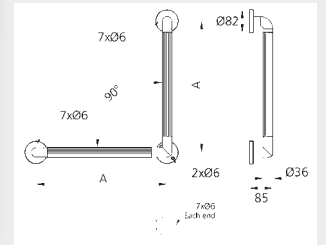

## Round flange steel back rest rail and pad

**BR2**

- Robust mild steel construction rail
- Durable wipe clean pad
- Saddle clips for fixing pad to rail

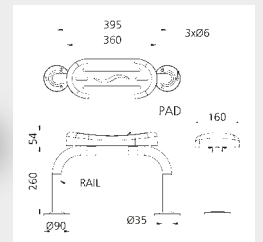

# White Disabled

## Standard replacement pad

### BR3

- Durable wipe clean pad

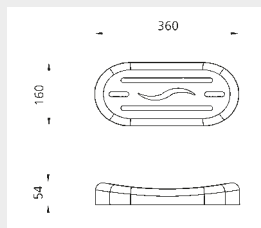

# White Disabled

## Floor to wall rail

### NS.FMR2

- Designed for use next to a WC or bath offering extra support
- 3 hole fixing points

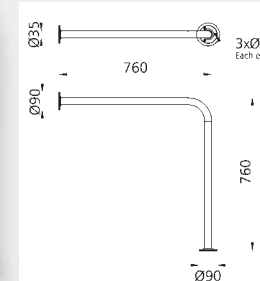

## Round end steel back rest rail

### BR4

- Robust mild steel construction
- Saddle clips for fixing pad to rail

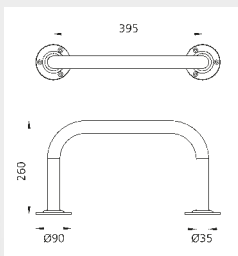

## Floor mounted round flange U-rail

### NS.FMR3

- Robust mild steel tubular construction
- Sturdy floor mounted design

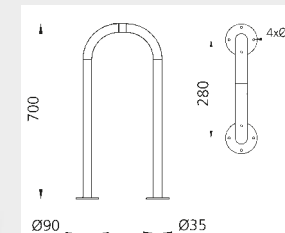

## Floor mounted bath side rail

### NS.FMR1

- Robust mild steel construction
- Fixes to floor and clamps over side of bath

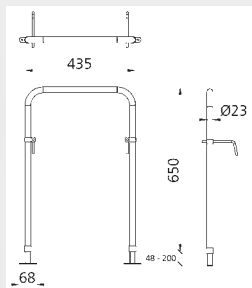

## Floor mounted U-rail

### NS.FMR4

- Robust mild steel construction
- Tubular floor fixing for increased stability

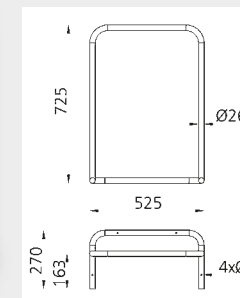

# White Disabled

## Floor to ceiling pole

Product Code	A (mm)
<b>NS.FP1</b>	2400
<b>NS.FP1</b>	2700

- Robust mild steel construction
- Durable epoxy coating
- Telescopic top flange for precise fitting

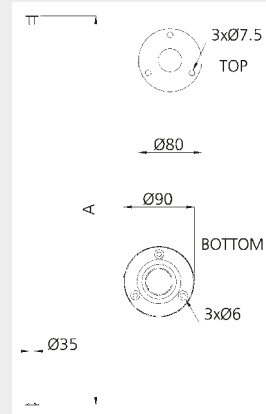

## Ribbed floor to ceiling pole

Product Code	A (mm)
<b>NS.FP1R</b>	2400
<b>NS.FP1R</b>	2700

- Fluted slip resistant grips

## Floor to ceiling pole with return to wall

**NS.FP3** - A-2700

- Robust mild steel construction
- Durable epoxy coating
- Telescopic top flange for precise fitting

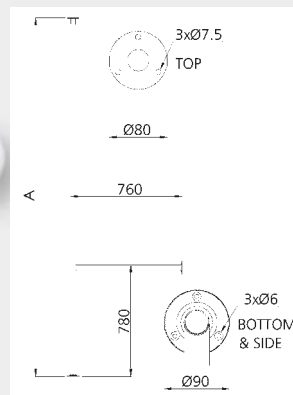

## Ribbed floor to ceiling pole with return to wall

**NS.FP3R** - A-2700

- Fluted slip resistant grips

# White Disabled

## Two flange stair rail

**NS.FSR2**

- Robust mild steel construction
- Durable epoxy coating
- Telescopic top flange for precise fitting

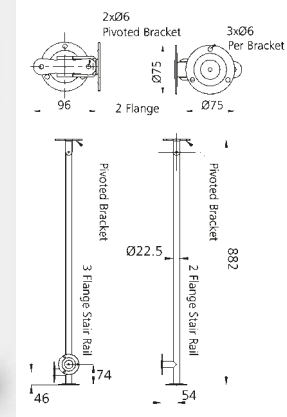

## Three flange stair rail

**NS.FSR3**

- Robust mild steel construction
- Optional two or three flange design
- Durable epoxy coating

## Hand rail bracket

**HRB1**

- Robust mild steel construction
- Designed to carry timber hand railing

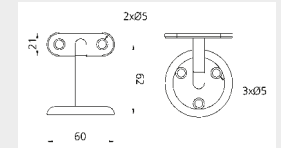

## Modular system - plastic fluted handrail tube

- Assembled using solvent cement giving permanent bond
- High quality extruded PVC plastic
- UV stabilised to prevent discolouration
- No electrical earthing required

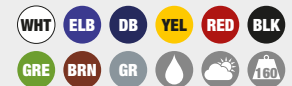

Product Code	A (mm)
<b>HRM1</b>	230
<b>HRM2</b>	330
<b>HRM3</b>	380
<b>HRM4</b>	530
<b>HRM5</b>	660
<b>HRM6</b>	690
<b>HRM7</b>	710

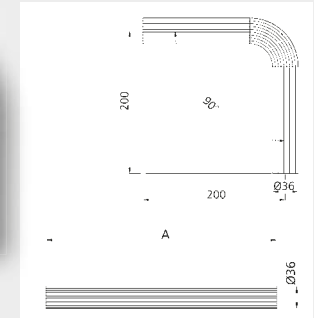
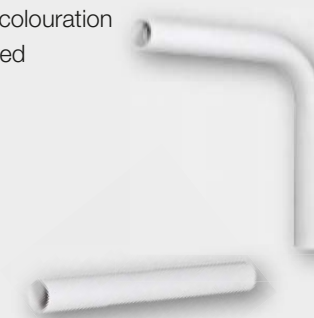

# White Disabled

# White Disabled

## Modular system - plastic handrail components

- Assembled using solvent cement giving permanent bond
- High quality extruded PVC plastic
- UV stabilised to prevent discolouration
- No electrical earthing required
- Plastic caps provided to cover screws

### HRM8

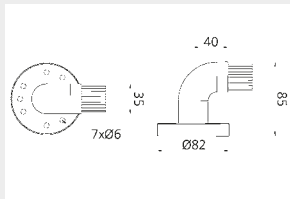

### HRM9

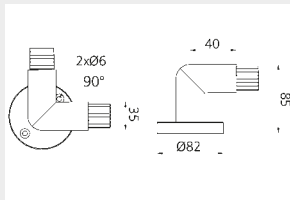

### HRM10

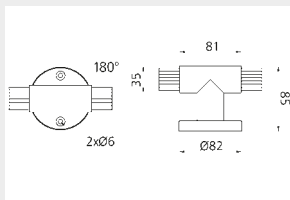

### HRM11

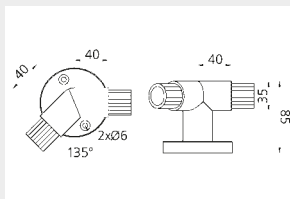

HRM12 - Adhesive 250ml

## Doc M toilet packs

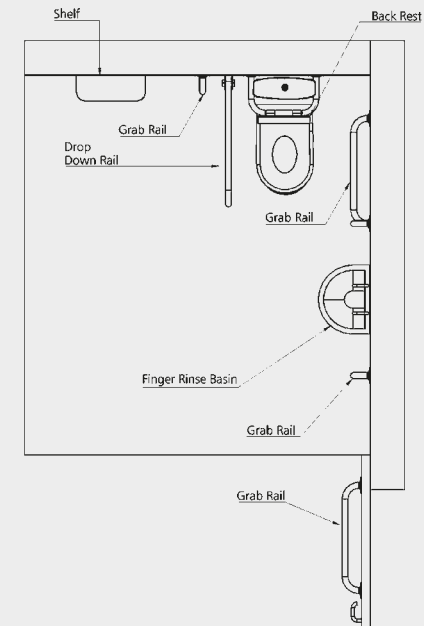
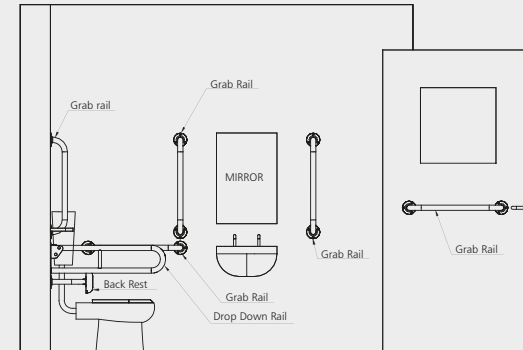

Drawings are for guidance only, please refer to relevant building regulations

## Rail only close coupled Doc M pack c/w trombone hinged rail



### DOCM1

- Simple one box solution to meet Doc M spec
- High resistance to vandalism
- All components available as individual products for continuity of specification



Contents	Qty
760mm Trombone hinged support rail	1
600mm Round flange steel grab rails	5

## Doc M shower packs

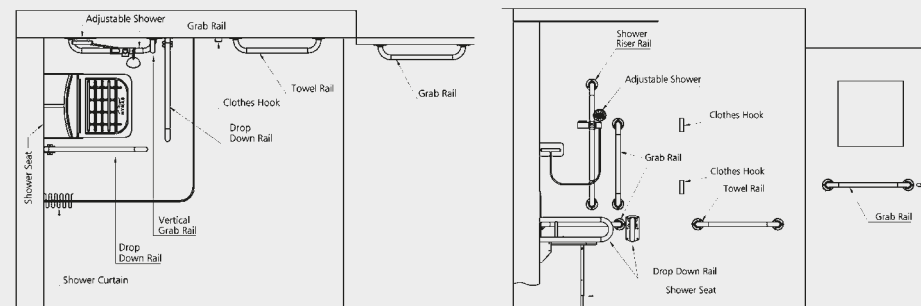

Drawings are for guidance only, please refer to relevant building regulations

## Rail only low level Doc M pack c/w trombone hinged rail



### DOCM2

- Simple one box solution to meet Doc M spec
- High resistance to vandalism
- All components available as individual products for continuity of specification



Contents	Qty
760mm Trombone hinged support rail	1
600mm Round flange steel grab rails	5
400mm Round flange back rest rail and pad	1

## Rail only disabled shower pack



### DOCMS1

- Simple one box solution for special needs shower areas
- High resistance to vandalism
- All components available as individual products for continuity of specification

Contents	Qty
760mm Trombone hinged support	2
600mm Round flange steel grab rail	3
900mm Round flange steel grab rail	1
Slider bracket	1
1200mm x 1200mm Shower track	1
2500mm x 2000mm Shower curtain	1
Doc M Shower seat	1



## Complete concealed disabled shower pack



### DOCMS2

- High resistance to vandalism
- All components available as individual products for continuity of specification
- One box solution

Contents	Qty
Concealed shower valve	1
Elbow for shower hose	1
Shower hose	1
Multifunction shower head	1
760mm Trombone hinged support rail	2
600mm Round flange steel grab rails	3
900mm Round flange steel grab rail	1
Slider bracket	1
1200mm x 1200mm Shower track	1
3000mm x 2000mm Shower curtain	1
Doc M Shower seat	1



## Complete concealed disabled shower pack



### DOCMS3

- High resistance to vandalism
- All components available as individual products for continuity of specification
- One box solution

Contents	Qty
Exposed shower valve	1
Shower hose	1
Multi function shower head	1
760mm Trombone hinged support rail	2
600mm Round flange steel grab rails	3
900mm Round flange steel grab rail	1
Slider bracket	1
1200mm x 1200mm Shower track	1
3000mm x 2000mm Shower curtain	1
Doc M Shower seat	1



## Doc M shower seat with legs



### NS.DSS1

- Extra projection shower seat for easy transfer onto seat
- Rust proof aluminium frame construction
- Closed cell structure PU pad for user comfort
- Height adjustable with both E-clip in 25mm increments and thread for fine adjustment

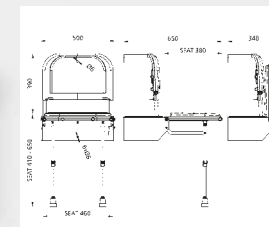

## Wall mounted shower seat with legs



### NS.DSS2

- Non corrosive aluminium frame construction
- Clip on moulded plastic seat
- Adjustable legs with both E-clip adjustment in 25mm increments and fine adjustment using threaded feet

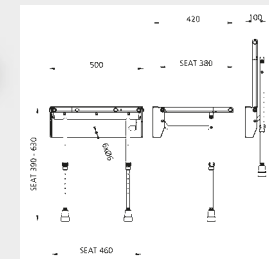

## Wall mounted shower seat with back, arms and legs



### NS.DSSC2

- Non corrosive aluminium frame construction
- Padded fold down padded arm rests
- Clip on moulded plastic seat
- Adjustable legs with both E-clip adjustment in 25mm increments and fine adjustment using threaded feet

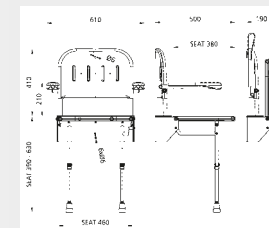

# White Disabled

# White Disabled

## Wall mounted padded shower seat with legs



### NS.DSS3

- Sturdy white epoxy coated aluminium frame
- Closed cell structure PU pad for user comfort
- Adjustable legs with both E-clip adjustment in 25mm increments and fine adjustment using threaded feet
- Clip on plastic moulded seat

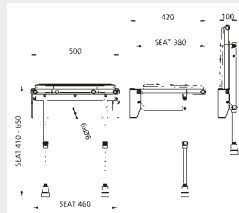

## Extra wide wall mounted padded shower seat with legs



### NS.DSS5

- Sturdy white epoxy coated aluminium frame
- Adjustable legs with both E-clip adjustment in 25mm increments and fine adjustment using threaded feet
- Clip on plastic moulded seat

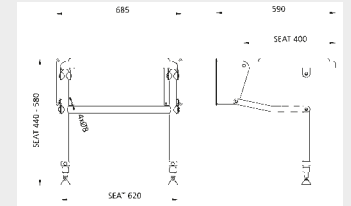

## Wall mounted padded shower seat with back, arms and legs



### NS.DSSC3

- Sturdy white epoxy coated aluminium frame
- Closed cell structure PU pad for user comfort
- Adjustable legs with both E-clip adjustment in 25mm increments and fine adjustment using threaded feet
- Clip on plastic moulded seat
- Padded fold down arm rests

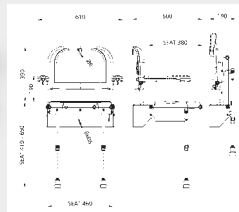

## Slatted shower seat with legs



### NS.DSS6

- Durable epoxy coated aluminium frame
- Plastic slats
- Leg support

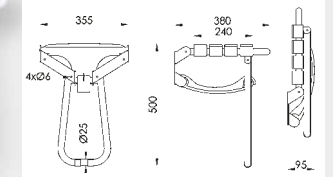

## Extra wide slatted shower seat with legs



### NS.DSS6E

- Durable epoxy coated aluminium frame
- Plastic slats
- Leg support

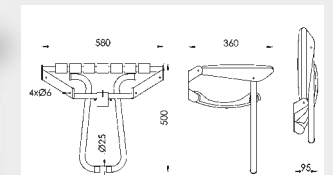

## Wall mounted padded horseshoe shower seat with back, arms and legs



### NS.DSS4

- Clip on plastic moulded horseshoe seat
- Sturdy white epoxy coated aluminium frame
- Closed cell structure PU pad for user comfort
- Adjustable legs with both E-clip adjustment in 25mm increments and fine adjustment using threaded feet
- Padded fold down arm rests

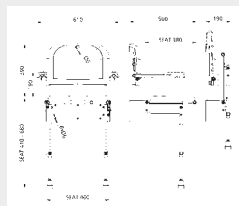

## Removable shower seat



### NS.DSS7

- Durable epoxy coated aluminium frame
- Plastic slats
- Leg support

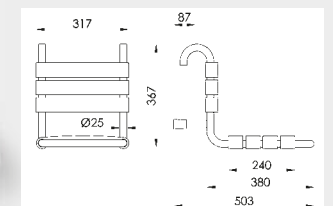



# A Grade Disabled

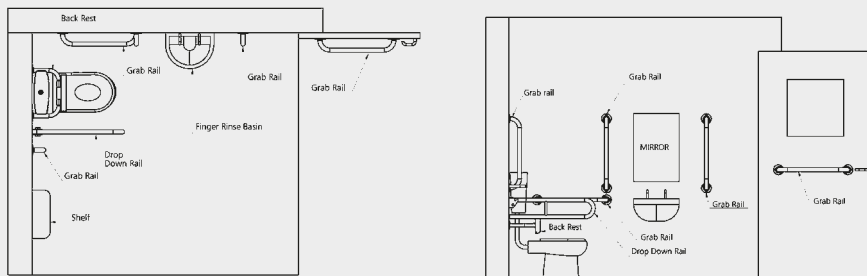

Drawings are for guidance only, please refer to relevant building regulations

# A Grade Disabled

Contemporary rail only close coupled Doc M pack



## DOC MC9

- Contemporary solution to meet Doc M spec
- High resistance to vandalism
- All components available as individual products for continuity of specification

Contents	Qty
800mm contemporary heavy duty hinged support rail	1
620 mm contemporary straight grab rail with concealed fixing	4
480mm contemporary straight grab rail with concealed fixing	1



Contemporary rail only low level Doc M pack



## DOC MC10

- Contemporary solution to meet Doc M spec
- High resistance to vandalism
- All components available as individual products for continuity of specification

Contents	Qty
800mm contemporary heavy duty hinged support rail	1
620 mm contemporary straight grab rail with concealed fixing	4
480mm contemporary straight grab rail with concealed fixing	1
Premium stainless steel back rest rail and pad with concealed fixing	1



# A Grade Disabled

## Contemporary rail only Doc M shower pack



### DOCMC11

- Contemporary solution to meet Doc M spec
- High resistance to vandalism
- All components available as individual products for continuity of specification

Contents	Qty
800mm contemporary heavy duty hinged support rail	2
620mm contemporary straight grab rail with concealed fixing	3
480mm contemporary straight grab rail with concealed fixing	1
900mm contemporary straight grab rail with concealed fixing	1
Slider Bracket	1
1200mm x 1200mm shower curtain track	1
1800mm x 2000mm weighted shower curtain	2
Doc M shower seat with legs	1
Robe hook	1

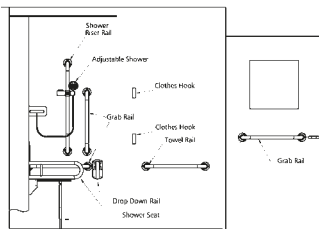
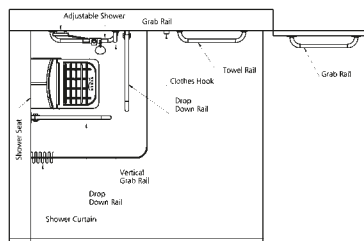

Drawings are for guidance only, please refer to relevant building regulations

# A Grade Disabled

## Complete contemporary exposed Doc M shower pack



### DOCMC12

- Contemporary solution to meet Doc M spec
- High resistance to vandalism
- All components available as individual products for continuity of specification
- Exposed shower valve for refurbishment projects

Contents	Qty
Exposed TMV3 thermostatic sequential shower valve - top & bottom outlet	1
Exposed two way diverter valve	1
Vandal resistant fixed shower head	1
Shower hose complete (1500mm)	1
Three function modern shower head	1
800mm contemporary heavy duty hinged support rail	2
620mm contemporary straight grab rail with concealed fixing	3
480mm contemporary straight grab rail with concealed fixing	1
900mm contemporary straight grab rail with concealed fixing	1
Slider bracket	1
1200mm x 1200mm shower curtain track	1
1800mm x 2000mm weighted shower curtain	2
Doc M shower seat with legs	1
Robe hook	1



# A Grade Disabled

## Complete contemporary concealed Doc M shower pack



### DOCMC13

- Contemporary solution to meet Doc M spec
- High resistance to vandalism
- All components available as individual products for continuity of specification
- Exposed shower valve for refurbishment projects

Contents	Qty
Concealed TMV3 thermostatic sequential shower valve	1
Minimalistic two way diverter valve	1
Vandal resistant fixed shower head	1
Elbow for shower kits with concealed valves	1
Shower hose complete (1500mm)	1
Three function modern shower head	1
800mm contemporary heavy duty hinged support rail	2
620mm contemporary straight grab rail with concealed fixing	3
480mm contemporary straight grab rail with concealed fixing	1
900mm contemporary straight grab rail with concealed fixing	1
Slider bracket	1
1200mm x 1200mm shower curtain track	1
1800mm x 2000mm weighted shower curtain	2
Doc M shower seat with legs	1
Robe hook	1



# A Grade Disabled

## Contemporary straight grab rail



### CGR2.32.900

- High quality polished stainless steel construction
- No electrical earthing required
- Unique two part flange cover for ease of fixing
- Ideally suited for use as slider bar in showers

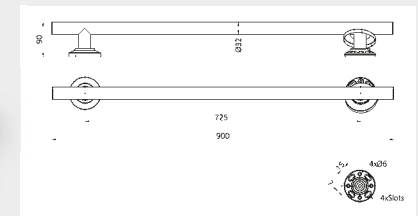

## Contemporary straight grab rail



### CGR3.32.355

- High quality polished stainless steel construction
- No electrical earthing required
- Unique two part flange cover for ease of fixing

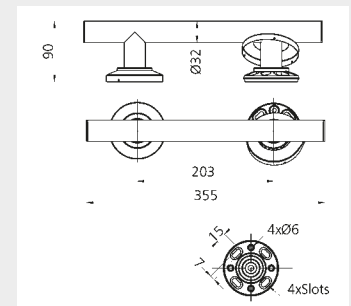

# A Grade Disabled

## Contemporary straight grab rail

### CGR4.32.480

- High quality polished stainless steel construction
- No electrical earthing required
- Unique two part flange cover for ease of fixing

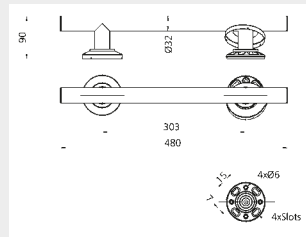

# A Grade Disabled

## Contemporary curved grab rail

### CGR7.32.480

- High quality polished stainless steel construction
- No electrical earthing required
- Unique two part flange cover for ease of fixing

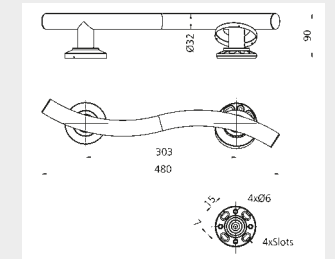

## Contemporary straight grab rail

### CGR5.32.620

- High quality polished stainless steel construction
- No electrical earthing required
- Unique two part flange cover for ease of fixing

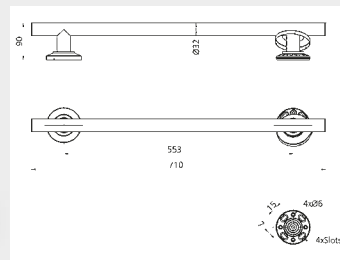

## Contemporary curved grab rail

### CGR9.32.620

- High quality polished stainless steel construction
- No electrical earthing required
- Unique two part flange cover for ease of fixing

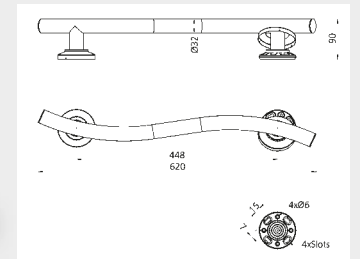

## Contemporary curved grab rail

### CGR6.32.355

- High quality polished stainless steel construction
- No electrical earthing required
- Unique two part flange cover for ease of fixing

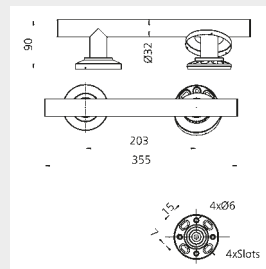

## Contemporary straight hinged rail

### HSR11

- High quality polished stainless steel construction
- No electrical earthing required
- Unique two part flange cover for ease of fixing

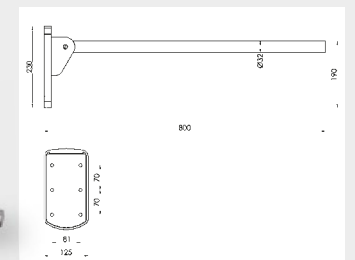

# A Grade Disabled

## Compact contemporary shower seat

### NS.WRSS1

- Very compact
- Simple installation

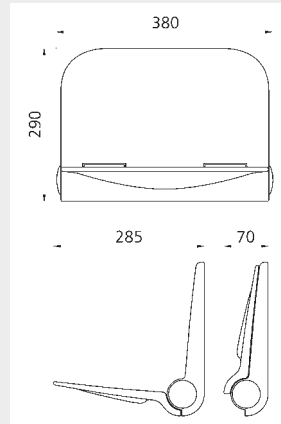

## Compact square padded contemporary shower seat

### NS.WRSS3

- Compact design
- Soft PU seat pad

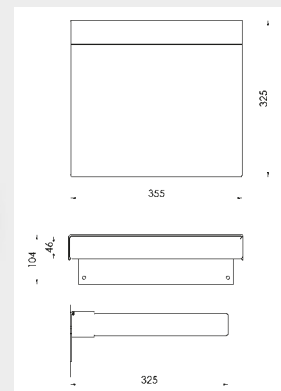

# A Grade Disabled

## Slimline contemporary shower seat

### NS.WRSS5

- Minimalistic contemporary design

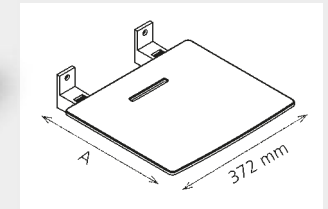

## Slimline contemporary shower seat with back rest

### NS.WRSS6

- Minimalistic contemporary design
- Back rest included

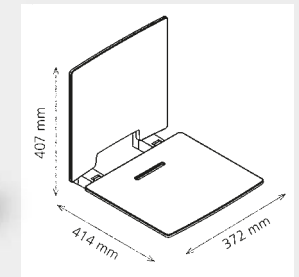

## Removable slimline contemporary shower seat with back rest

### NS.WRSS7

- Minimalistic contemporary design
- Back rest included
- Removable for ease of storage

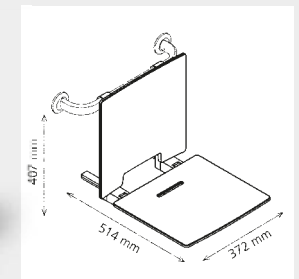

# Anti Ligature

## Anti ligature pull handle

### AG-AL.PH300

Proposed Classification in accordance with DHF Technical Specification 001:  
Door mounted anti-ligature devices for safety & security purposes: November 05

3	-	-	1	4	3	-	A
---	---	---	---	---	---	---	---

SSS

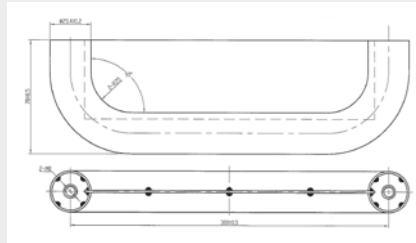

## Anti ligature stainless steel grab rail with plate infill

- Vandal resistant stainless steel construction
- Ligature free design

WHT DB PSS SSS 190 LW

	A (mm)
NS.AL.PH450	450
NS.AL.PH600	600

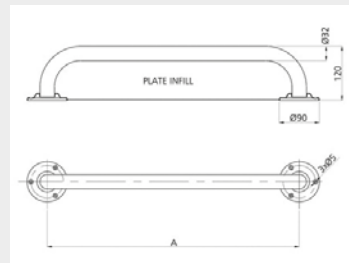

# Anti Ligature

## Anti ligature automatic soap dispenser

### NS.AL.0012

- Anti-vandal Installed recessed into wall to improve resistance to damage
- Lock can be made to suit existing master keyed suite

SSS PSS



## Anti ligature paper towel dispenser

### NS.AL.0013

- Anti-vandal
- High Quality 1.5mm stainless steel with 2mm thick cover plate
- Installed either surface mounted or concealed fix by recessing into wall
- 450x350
- Available as combined soap and towel dispenser (**NS.AL.0013ST**)

SSS PSS



## Anti ligature waste bin

### NS.AL.0014

- Anti-vandal
- 450 x 350 200mm

SSS



# Anti Ligature

## Anti ligature collapsible robe hook

### NS.AL.001

- Vandal resistant stainless steel construction
- Ligature free design



SSS

## Anti ligature multiple hook

### NS.AL.0015

- Ligature free design



SSS

## Anti ligature towel rail

### NS.AL.002

- Unique magnetic bracket system gives way under abnormal force
- Light weight durable aluminium rail
- Length 500mm



WHT

## Anti ligature shelf

### NS.AL.003

- Unique magnetic bracket system gives way under abnormal force
- Variety of accessories available on similar mounting plate



WHT

## Anti ligature toilet roll holder – lockable

### NS.AL.004

- Unique magnetic bracket system gives way under abnormal force
- Variety of accessories available on similar mounting plate



WHT

# Anti Ligature

## Anti ligature soap dispenser

### NS.AL.005

- Unique magnetic bracket system gives way under abnormal force
- Variety of accessories available on similar mounting plate



WHT

## Anti ligature soap dish

### NS.AL.006

- Unique magnetic bracket system gives way under abnormal force
- Variety of accessories available on similar mounting plate



WHT

## Anti ligature paper towel dispenser

### NS.AL.007

- Unique magnetic bracket system gives way under abnormal force
- Variety of accessories available on similar mounting plate



WHT

## Stainless steel mirror

- High quality 1.2mm thick highly polished stainless steel mirror

	A (mm)	B (mm)
NS.AL.008.700	400	700
NS.AL.008.1000	400	1000



WHT

## Anti ligature shower curtain track

- Unique magnetic bracket system gives way under abnormal force
- High quality flexible plastic curtain track which cannot be used as a weapon

	A (mm)	B (mm)
NS.AL.009	750	750
NS.AL.0010	1200	1200
NS.AL.0011	1650	750



WHT

Offset hinge 90° **PCP SCP**  
**GHA-02**

Offset bracket 90° **PCP**  
**GHA-02F**

Glass to glass hinge 180° **PCP**  
**GHA-05**

Centre hung hinge 90° **PCP**  
**GHA-01**

Centre hung bracket 90° **PCP**  
**GHA-01F**

Glass to glass hinge 135° **PCP**  
**GHA-04-135**

Designer hinge 90° **PCP**  
**GHJ-01A**

Designer bracket 90° **PCP**  
**GHJ-01F**

Designer glass to glass 90° **PCP**  
**GHJ-02F**

Header panel support bar 90° **PCP**  
**GT-201**

Wall 90° Bar Bracket

Header panel support bar 45° **PCP**  
**GT-203**

Wall 45° Bar Bracket

Glass to glass support bar **PCP**  
**GT-204**

Glass Bar Bracket with a Swiveling U-Shaped 360°

'Y' inline panel seal for 90° **WS1**

Polycarbonate door jamb for 135° **WS2**

Polycarbonate 'U' with leg and seal for 90° **WS3**

Dual durometer PVC seal and wipe **WS4**

Co-extruded clear bottom wipe with drip rail **WS5**

Polycarbonate bottom rail with drip wipe **WS6**

Polycarbonate 'h' jamb for 180° **WS7**

Magnetic seal for 180° **WS8**

Magnetic seal for 90° **WS9**



# No Touch Controls

## Doc M Packs

### NT.DOCM1

Close coupled Doc M pack, no touch sensor flush/WM infra-red tap, no tap hole basin (rear outlet) or left or right hand tap-hole (bottom outlet)



### NT.DOCM2

Close coupled Doc M pack, manual flash & tap, no tap hole basin (rear outlet) or left or right hand tap-hole with bottom outlet



### NT.DOCM3

Back-to-wall Doc M Pack, auto no-touch sensor flush/WM infra-red tap, no tap hole basin (rear outlet) or left or right hand taphole (bottom outlet)



# No Touch Controls

## Doc M Packs

### NT.DOCM4

Back to wall Doc M Pack. No Manual flush & tap, no tap hole basin (rear outlet) or left or right hand taphole with bottom outlet



### NSNT.SD



Surface mounted hands free soap dispenser



### NSNT.PD



Paper towel dispenser



### NSNT.HD



Fully recessed DDA compliant hand dryer



# Newstar Notes



Full Architectural Ironmongery Catalogues  
available upon request

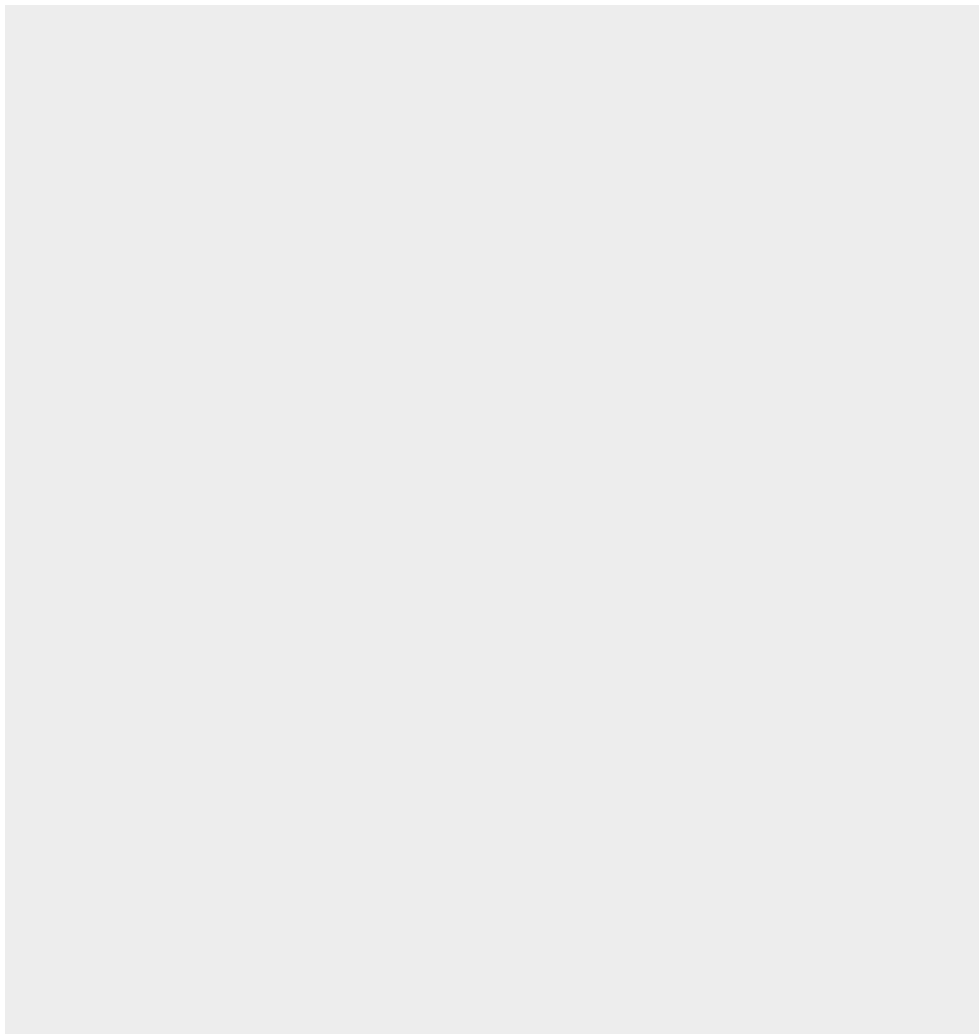

Architectural  
Ironmongery

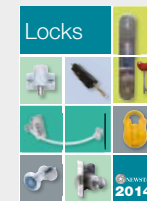

Grid Range Locks  
& Cylinders

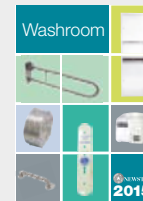

Washroom, Bathroom  
& Disabled Fittings



National Key Scheme  
Locks & Keys

## Contacts

Sales

T: (01474) 353111

F: (01474) 353911

E: [sales@new-star.co.uk](mailto:sales@new-star.co.uk)

W: [new-star.co.uk](http://new-star.co.uk)



# NEWSTAR

Distributed by

**Newstar Door Controls Limited, Unit 2, Block A Lion Business Park, Dering Way, Gravesend, Kent DA12 2DN.**

**T:** (01474) 353111 **F:** (01474) 353911 **E:** sales@new-star.co.uk **W:** new-star.co.uk

All illustrations and dimensions given in this brochure are subject to change due to the continual refining and improving of the product range. Therefore we reserve the right to alter specification without prior notice. Any products purchased from this brochure are subject to our standard terms and conditions which are available upon request. November 2014. ● **impact** createwithimpact.com (E2543/LU)